

C-Series Cylinders



COMPACT[®]
AUTOMATION PRODUCTS



C-Series Cylinders: Table of Contents

C-Series

Slide Featurespg. 2

CD and CE Seriespg. 3

Quick Referencepg. 3

How to Order:

C Seriespg. 4

Options:

C Seriespg. 5

Dimensional Data

CD Seriespg. 6

CE Seriespg. 7

Engineering Data

CD and CE Series Seriespgs. 8-17

Warrantypg. 18

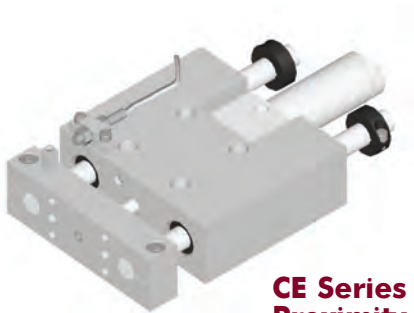

CE Series Slide with Proximity Switch Pg. 2

CD Series Slide with Proximity Switch and Shock Package Pg. 2

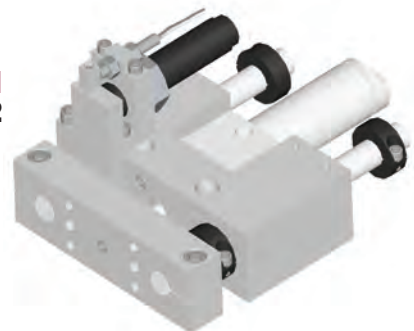

C-Series Slide Features

CD Series Slide with Proximity Switch and Shock Package

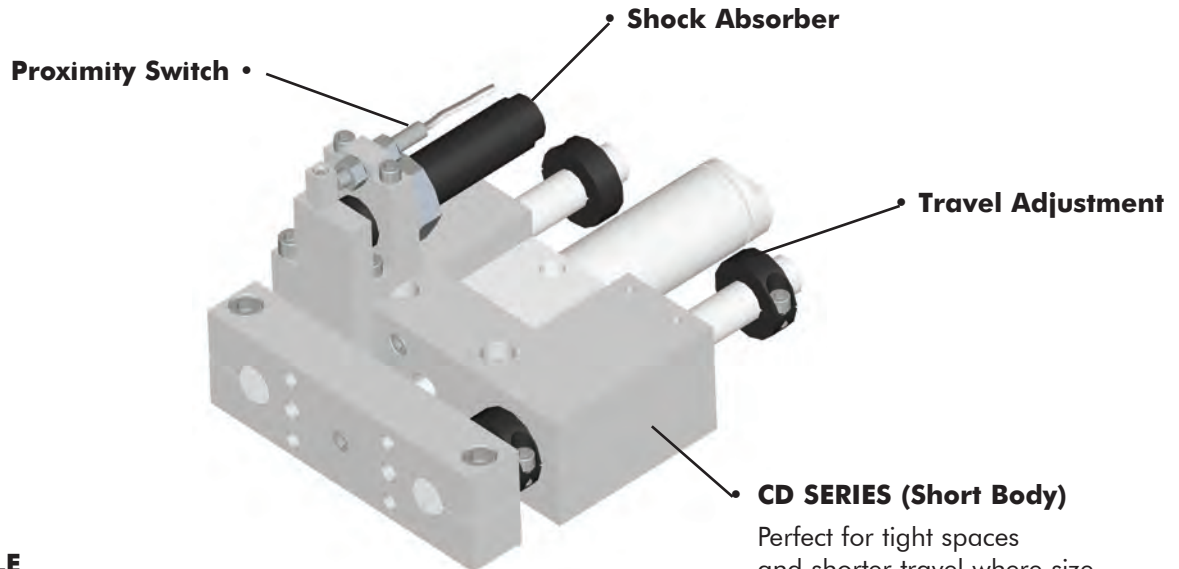

CYLINDER STYLE

- Stainless Round Line Cylinders

CD SERIES (Short Body)
Perfect for tight spaces and shorter travel where size and weight are critical

GUIDE ROD MATERIALS

- Standard Hardened Carbon Steel
- Hardened Stainless Steel

GUIDE ROD/BUSHING DIAMETERS

- Standard – solid performance with linear ball or composite bushings
- Oversize – greatest rigidity with minimal deflection

TOOLING PLATE

- Pinch type tooling plate connection improves rigidity providing a sturdy system ideal for precise movement and accurate location

CE Series Slide with Proximity Switch

GUIDE BUSHINGS

Composite or Linear ball

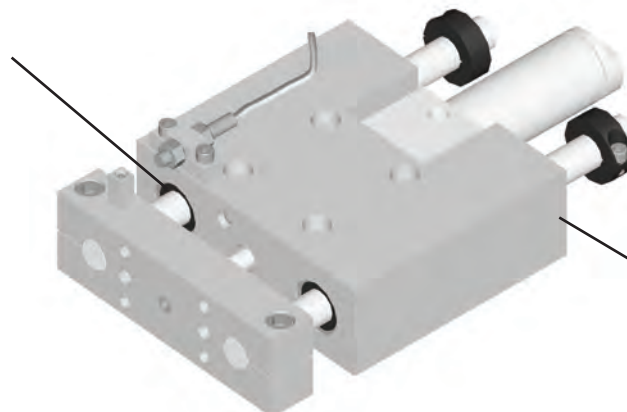

CE SERIES (Long Body)

Offers greater distance between the bearings, longer travel and higher load

CD and CE Series

GUIDED SLIDES:

- **Cylinders – Stainless Steel Round Line Style**
 - Available Bores 3/4", 1-1/16", 1-1/4", 1-1/2" and 2".
- **Slide Bodies – Anodized machined aluminum**
 - CD (Short Body) perfect for tight space and shorter travel where size and weight are critical.
 - CE (Long Body) the longer body spreads the distance between the guide bushings, contributes to rod rigidity, best for longer strokes and higher load applications.
- **Guide Bushings Types – (2 per Guide Rod)**
 - Linear Ball with shaft seals, high precision.
 - Composite (flouropolymer) Internally lubricated, high performance and cost effective.
- **Guide Rod Types**
 - Hard precision ground shafts provide smooth tooling plate motion under load.
 - Oversize shafting utilized with composite bearing for greater rigidity with minimum rod deflection.
- **Guide Rod Materials (Precision Ground – Class L)**
 - Standard hardened steel.
 - Hardened stainless steel.
 - Aluminum ceramic coated light weight

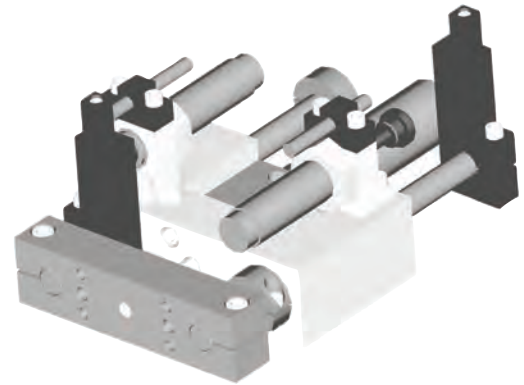

- **Tooling Plates**
 - Machined mounting face
 - Combination tapped and counterbored mounting holes
 - Close fit dowel pin holes
 - Pinch type tooling plate connection
- **Options**
 - Shock pads
 - Stop collars
 - Shock absorber mounting
 - Proximity switch ready
 - Reed & solid state switches available
 - Normal fit dowel pin holes available

Quick Reference

Piston Area (in ²)				
Size	Bore	Extend	Retract	Pist. Rod Diam.
22	3/4"	.44	.39	1/4"
23	1-1/16"	.89	.81	5/16"
24	1-1/4"	1.23	1.12	3/8"
25	1-1/2"	1.77	1.62	7/16"
26	2"	3.14	2.95	1/2"

Port Size	
Slide Size	Standard Port Size
22	1/8 NPT
23	1/8 NPT
24	1/8 NPT
25	1/8 NPT
26	1/4 NPT

BEARING TYPE	DIAMETERS	GUIDE ROD	NON-REPAIRABLE
		CYLINDER BORE	
Linear Ball		3/8"	3/4"
Std Composite		3/8"	
Over Size Composite		1/2"	
Linear Ball		1/2"	1-1/16"
Std Composite		1/2"	
Over Size Composite		5/8"	
Linear Ball		5/8"	1-1/4"
Std Composite		5/8"	
Over Size Composite		3/4"	
Linear Ball		3/4"	1-1/2"
Std Composite		3/4"	
Over Size Composite		1"	
Linear Ball		1"	2"
Std Composite		1"	
Over Size Composite		1-3/8"	

How to Order: C Series Slides

SERIES BODY STYLE BUSHING TYPE SIZE SLIDE TRAVEL TOOLING PLATE GAP OPTIONS OPTIONS

C D B - 24 X 2.25 X 2 - Q - AR

1 2 3 4 5 6 7 7

1

Series	
C	Slide

2

Body Style	
D	Short Body
E	Long Body

3

Bushing Type	
B	Linear Ball Bushings
C	Standard Composite Bushings
D	Oversize Composite Bushings

4

Size			
Size	Guide Rod Diameter		Bore
	Standard	Oversize	
22	3/8"	1/2"	3/4"
23	1/2"	5/8"	1-1/16"
24	5/8"	3/4"	1-1/4"
25	3/4"	1"	1-1/2"
26	1"	1-3/8"	2"

5

Slide Travel (Ex. 2-1/4" = 2.25") Slide Type - Travel Range	
Body Style 'D'	
22	.25 inch to 12.00 inches
23	.25 inch to 14.00 inches
24	.25 inch to 18.00 inches
25	.25 inch to 18.00 inches
26	.25 inch to 22.00 inches
Body Style 'E'	
22	.25 inch to 16.00 inches
23	.25 inch to 18.00 inches
24	.25 inch to 24.00 inches
25	.25 inch to 24.00 inches
26	.25 inch to 28.00 inches
Available in .25" increments. CF for longer travel lengths.	

6

Tooling Plate Gap	
Additional distance between tooling plate and bearing block in 1" increments.	
Example 2 = 2 inches (specify only if needed)	

7

Options Cylinder Options	
Q	Hardened Stainless Steel Guide Rods
M	Magnetic Piston ²
U7	Ports and Cushions- Position 3
V1	Flourelastomer Seals
DB	Cushions- Both Ends ²

NOTES:

1. The selection of this option will affect the overall length of the slide.

7

Options Mount Options	
GX	Side Mount- Position 4
GV	Side Mount- Position 2
J2	Dowel Pin in Tooling Plate- Normal Fit ³
J6	Dowel Pins in Body- Normal Fit

Switches (Includes Mtg Brkt.) (for use with 3/4" and 1-1/16" Bore)		Switches (Includes Mtg Brkt.) (for use with 1-1/4" Thru 2" Bore)	
Part#	Description	Part#	Description
KL790	Reed	KL690	Reed
KL791	PNP	KL691	PNP
KL792	NPN	KL692	NPN
KL793*	Reed QD	KL693*	Reed QD
KL794*	PNP QD	KL694*	PNP QD
KL795*	NPN QD	KL695*	NPN QD
A201A	Cordset Only	A201A	Cordset Only

*Includes 5 meter cordset.

Options— C Series

7

Options ^{4,7} Stop Collar Options		
Std*	Quiet*	
AR	AT	Stop Collar w/ Bumper Retract only.
AE	AS	Stop Collar w/ Bumper Extend only.
GG	G22	Stop Collar w/ Bumper- Ext with Prox. Provision for Both Extend and Retract.
GH	G23	Stop Collar w/ Bumper- Ret. with Prox. Provision for Retract only.
GI	G24	Stop Collar w/ Bumper- Both with Prox. Provision for Both Extend and Retract.

NOTES:

4. "Quiet" Bumper end of stroke location may vary due to compression of the bumper material.

* The "Standard" Bumper is a 95a durometer urethane that significantly reduces noise.
The "Quiet" Bumper is a 50a durometer soft urethane, which will compress to absorb end of stroke impact.

7

Options ^{5,6,7,8} Shock and Sensing Options	
GM	Provision for Shock- Extend
GN	Provision for Shock- Retract
GO	Provision for Shock- Both
G2	Shock and 8mm Prox. Ready- Both
G3	Shock and 8mm Prox. Ready- Ext.
G4	Shock and 8mm Prox. Ready- Ret.
G12	Shock and 12mm Prox. Ready-Both
G13	Shock and 12mm Prox. Ready-Ext.
G14	Shock and 12mm Prox. Ready-Ret.

NOTES:

5. Shock absorbers and proximity switches must be ordered separately for options GM, GN, GO, G2, G3, G4, G12, G13, and G14.
6. Options GM, GN and GO provide for the the mounting of shock absorbers. It includes guide rod mounted shock stop plates, a stop collar on the opposite guide rod, and slide body mounting holes for the shock absorbers brackets. (DOES NOT INCLUDE THE SHOCK ABSORBERS or MOUNTING BRACKETS).

7

Options ^{4,9} Bumper Options		
Std*	Quiet*	
BR	BJ	Bumper Retract
BS	BK	Bumper Extend when combined with GM, GO, G2, G3, G12, G13 Options.
BT	BL	Bumper Retract when combined with GN, GO, G2, G4, G12, G14 Options.

NOTES:

7. Travel Adjustment Options, Bumper Options, Shock Options, and Sensing Options affect the overall length of the slide.
8. G2, G3, G4, G12, G13, and G14 are Shock and Prox. Ready Options These include the mounting holes and shock bracket, guide rod mounted shock stop, stop collar mounted on the opposite guide rod, and mounted prox. bracket, and target. (DOES NOT INCLUDE THE SHOCK ABSORBER or PROX. SWITCH).
9. Tooling plate extension is not available with bumper option (BR & BJ).

Stop & Travel Adjustments Kits*							
			Slide Size				
	Bumper	Guide Rod	22	23	24	25	26
Travel Adjustment -AR or -AE	Standard	Standard	KARS22	KARS23	KARS24	KARS25	KARS26
		Oversize	KARO22	KARO23	KARO24	KARO25	KARO26
Travel Adjustment -AT or -AS	Quiet	Standard	KATS22	KATS23	KATS24	KATS25	KATS26
		Oversize	KATO22	KATO23	KATO24	KATO25	KATO26
Prox & Trav adj -GG or -GH	Standard	Standard	KGGS22	KAGS23	KAGS24	KAGS25	KAGS26
		Oversize	KGGO22	KAGO23	KAGO24	KAGO25	KAGO26
Travel Adjustment -G22 or -G23	Quiet	Standard	KG2S22	KG2S23	KG2S24	KG2S25	KG2S26
		Oversize	KG2O22	KG2O23	KG2O24	KG2O25	KG2O26
Shock Absorber Stop -GM or -GN	N/A	Standard	KGMS22	KGMS23	KGMS24	KGMS25	KGMS26
		Oversize	KGMO22	KGMO23	KGMO24	KGMO25	KGMO26

*For Models with "Z1" Option add "Z" to the end of the kit # (Ex: KARS22 becomes KARS22Z).

Dimensional Data— CD Series

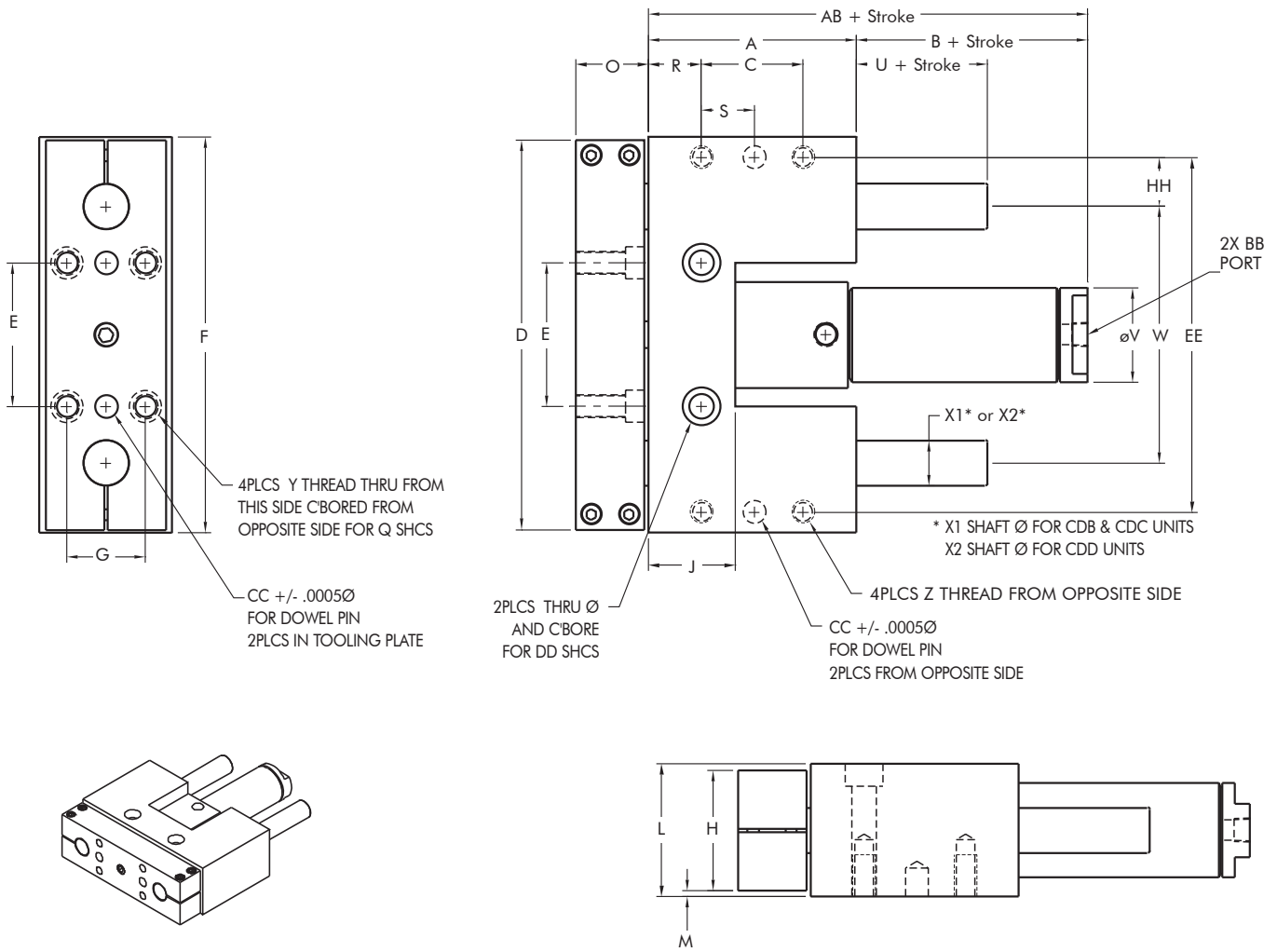

Dimensional Specifications CD Slide															
Bore	Size	A	B	C	D	E	F	G	H	J	L	M	O	Q	R
3/4	22	2.39	1.27	1.37	3.80	1.63	3.88	0.58	1.00	0.79	1.20	0.10	0.70	#10	0.50
1-1/16	23	2.88	1.49	1.50	4.72	1.88	4.82	0.75	1.25	0.98	1.50	0.13	0.95	#10	0.63
1-1/4	24	3.39	2.53	1.75	5.40	2.00	5.50	0.90	1.50	1.48	1.70	0.10	0.95	1/4	0.75
1-1/2	25	3.65	1.69	1.75	6.45	2.38	6.55	1.30	2.00	1.50	2.20	0.10	1.20	5/16	0.88
2	26	5.00	1.82	3.00	8.37	3.12	8.50	1.63	2.50	1.70	2.75	0.13	1.45	3/8	1.00

Dimensional Specifications CD Slide															
Bore	Size	S	U	V	W	X1	X2	Y	Z	AB	BB	CC	DD	EE	HH
3/4	22	0.50	0.16	0.81	2.63	0.38	0.50	1/4-20	#10-24	3.66	1/8 NPT	3/16	1/4	3.44	0.41
1-1/16	23	0.75	0.00	1.13	3.25	0.50	0.63	1/4-20	1/4-20	4.37	1/8 NPT	1/4	5/16	4.33	0.54
1-1/4	24	0.88	0.04	1.31	3.63	0.63	0.75	5/16-18	1/4-20	5.27	1/8 NPT	1/4	3/8	5.00	0.69
1-1/2	25	0.88	0.03	1.56	4.25	0.75	1.00	3/8-16	3/8-16	5.46	1/8 NPT	3/8	3/8	5.88	0.81
2	26	1.50	0.18	2.06	5.75	1.00	1.38	1/2-13	3/8-16	6.18	1/4 NPT	3/8	1/2	7.75	1.00

Dimensional Data— CE Series

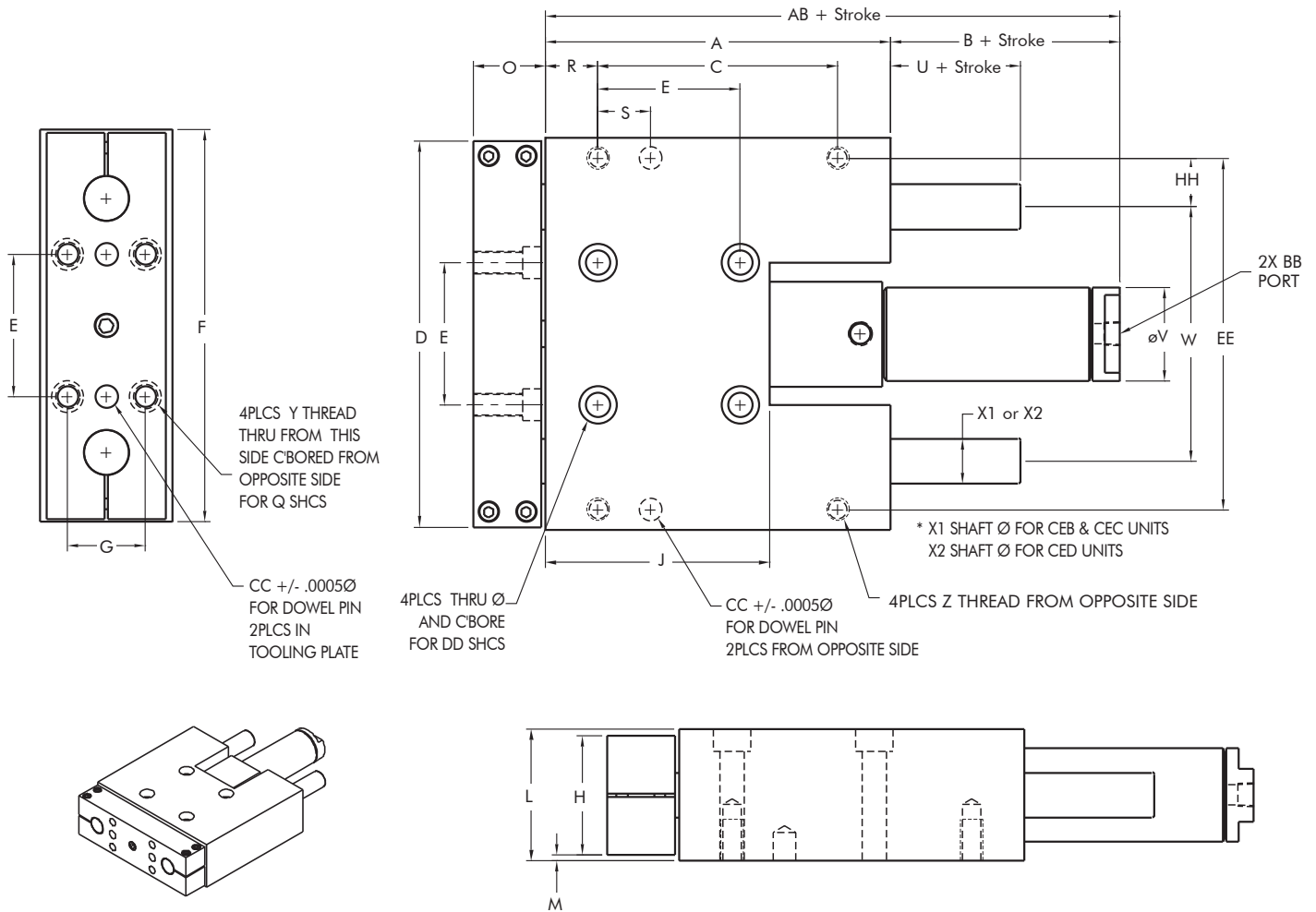

Dimensional Specifications CE Slide															
Bore	Size	A	B	C	D	E	F	G	H	J	L	M	O	Q	R
3/4	22	4.14	1.27	3.13	3.80	1.63	3.88	0.58	1.00	2.54	1.20	0.10	0.70	#10	0.50
1-1/16	23	4.77	1.61	3.50	4.72	1.88	4.82	0.75	1.25	2.98	1.50	0.13	0.95	#10	0.63
1-1/4	24	5.02	2.8	3.50	5.40	2.00	5.50	0.90	1.50	3.23	1.70	0.10	0.95	1/4	0.75
1-1/2	25	5.77	1.95	4.00	6.45	2.38	6.55	1.30	2.00	3.75	2.20	0.10	1.20	5/16	0.88
2	26	8.00	1.18	6.00	8.38	3.13	8.50	1.63	2.50	4.70	2.75	0.13	1.45	3/8	1.00

Dimensional Specifications CE Slide															
Bore	Size	S	U	V	W	X1	X2	Y	Z	AB	BB	CC	DD	EE	HH
3/4	22	0.50	0.16	0.81	2.63	0.38	0.50	1/4-20	#10-24	5.41	1/8 NPT	3/16	1/4	3.44	0.41
1-1/16	23	0.75	0.16	1.13	3.25	0.50	0.63	1/4-20	1/4-20	6.37	1/8 NPT	1/4	5/16	4.33	0.54
1-1/4	24	0.88	0.16	1.31	3.63	0.63	0.75	5/16-18	1/4-20	7.02	1/8 NPT	1/4	3/8	5.00	0.98
1-1/2	25	0.88	0.16	1.56	4.25	0.75	1.00	3/8-16	3/8-16	7.72	1/8 NPT	3/8	3/8	5.88	0.81
2	26	1.50	0.18	2.06	5.75	1.00	1.38	1/2-13	3/8-16	9.18	1/4 NPT	3/8	1/2	7.75	1.00

Engineering Data— CD & CE Series

Maximum Rolling Load & Deflection Graphs

The following pages contain load graphs to assist in determining maximum loads based on acceptable life. The red lines represent deflection figures based on the effect of external loads. Bearing alignment, shaft weight and shaft straightness will affect the accuracy of the tooling plate location.

NOTE: Load out in front of tooling plate? Include the distance the load is out from the tooling plate as part of the travel length when following the graphs.

CDB22 with 3/8" Shafts and Linear Ball Bushings

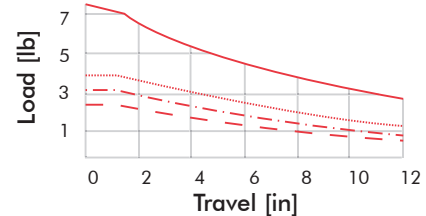
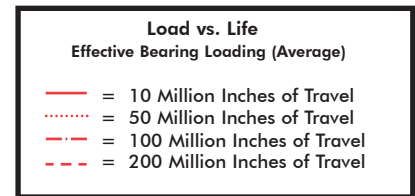
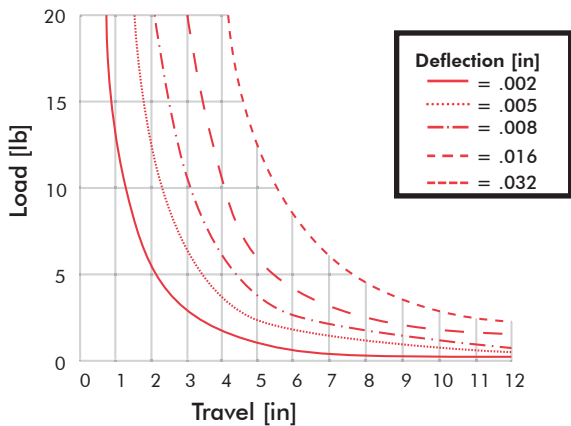

CDC22 with 3/8" Shafts and Composite Bushings

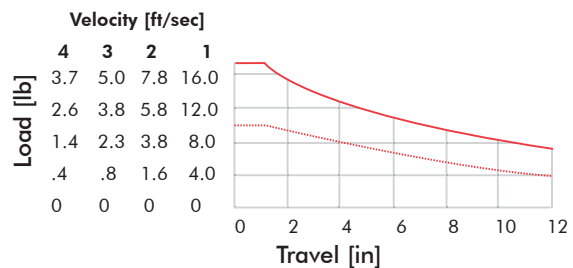
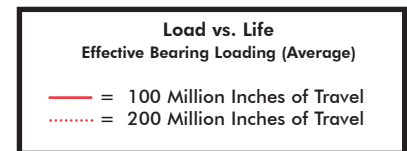
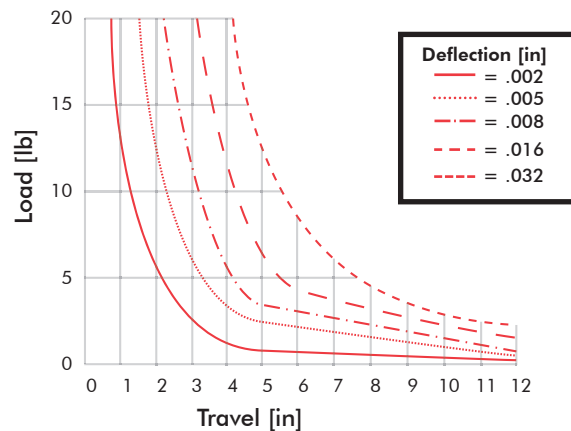

CDD22 with 1/2" Shafts and Composite Bushings

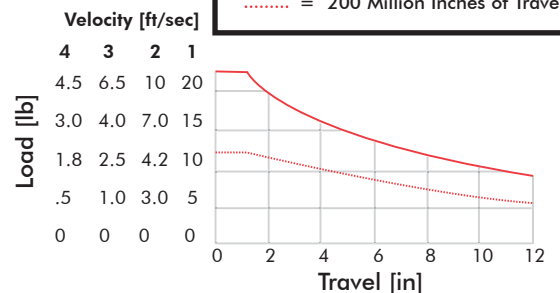
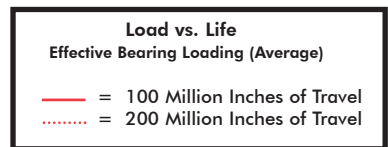
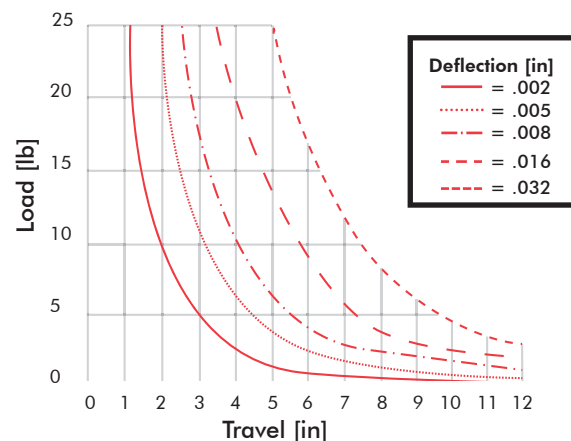

Engineering Data— CD & CE Series

Maximum Rolling Load & Deflection Graphs

CEB22 with 3/8" Shafts and Linear Ball Bushings

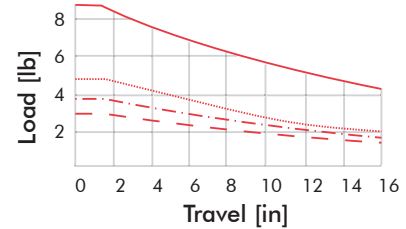
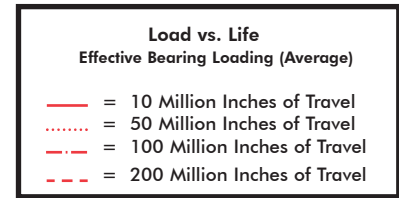
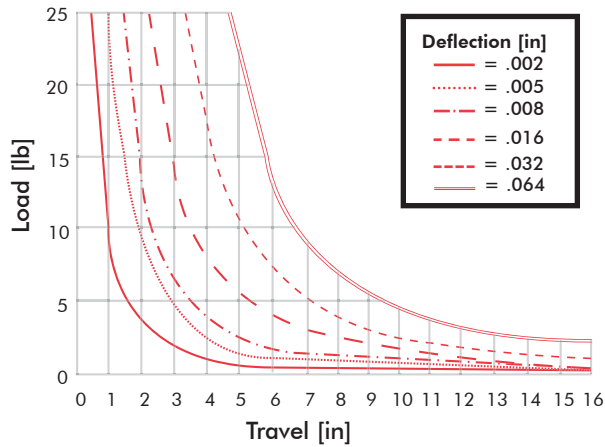

CEC22 with 3/8" Shafts and Composite Bushings

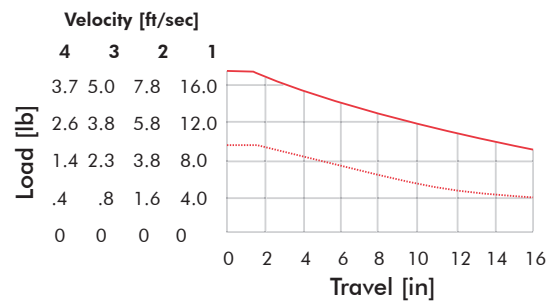
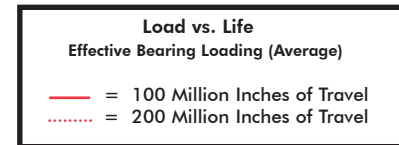
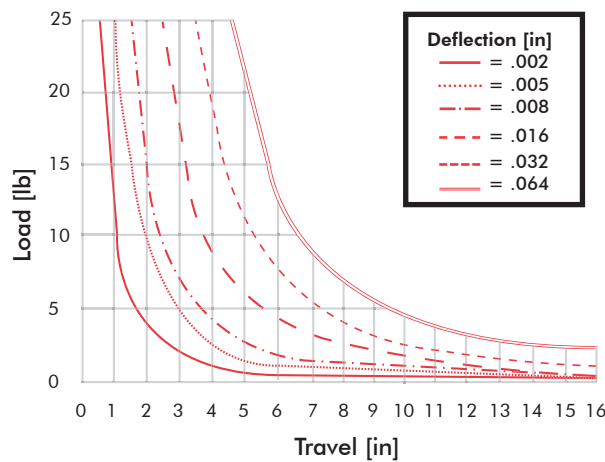

CED22 with 1/2" Shafts and Composite Bushings

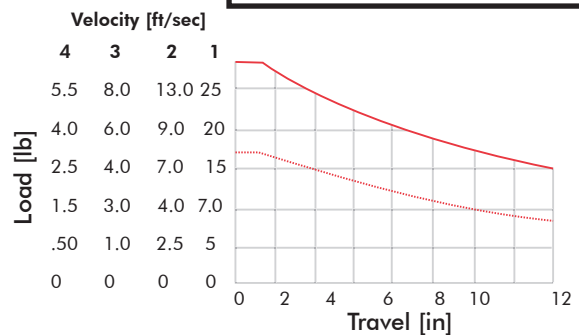
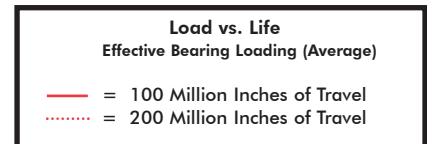
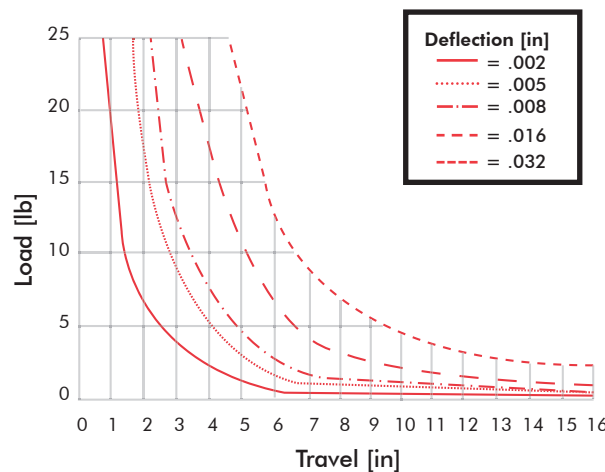

Engineering Data— CD & CE Series

Maximum Rolling Load & Deflection Graphs

CDB23 with 1/2" Shafts and Linear Ball Bushings

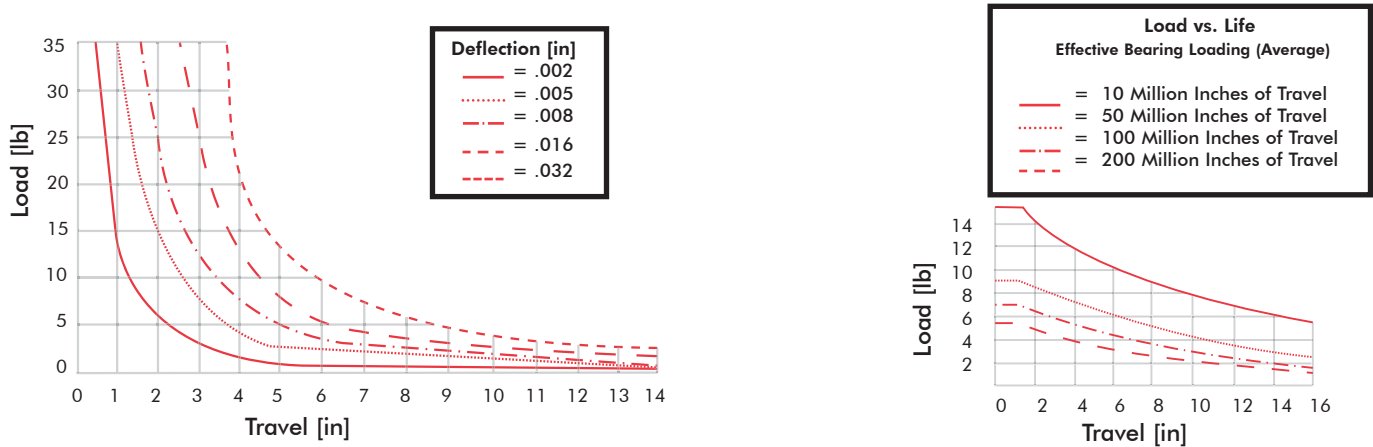

CDC23 with 1/2" Shafts and Composite Bushings

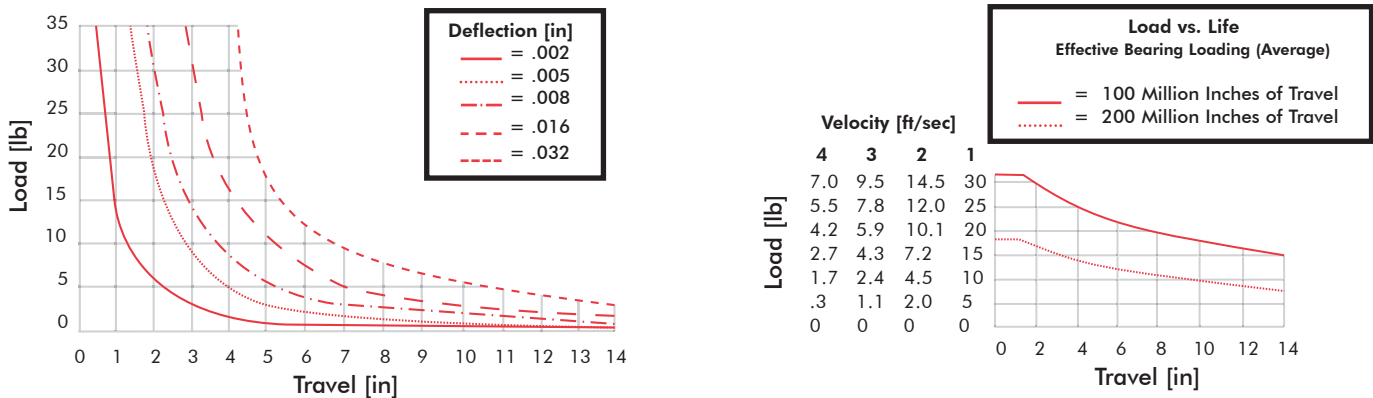

CDD23 with 5/8" Shafts and Composite Bushings

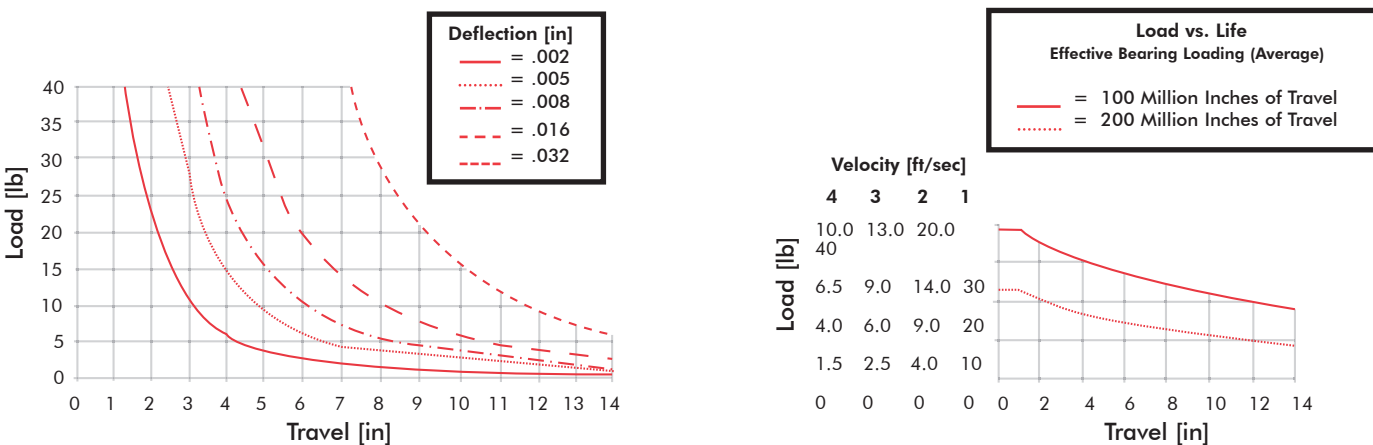

Engineering Data— CD & CE Series

Maximum Rolling Load & Deflection Graphs

CEB23 with 1/2" Shafts and Linear Ball Bushings

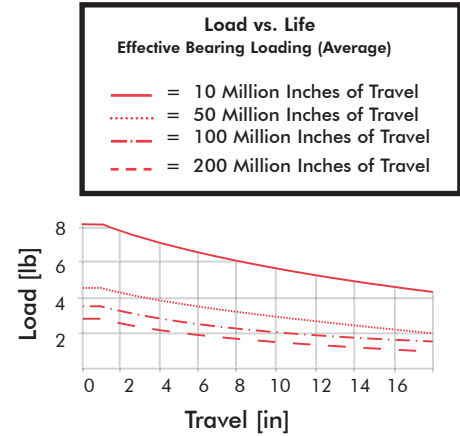
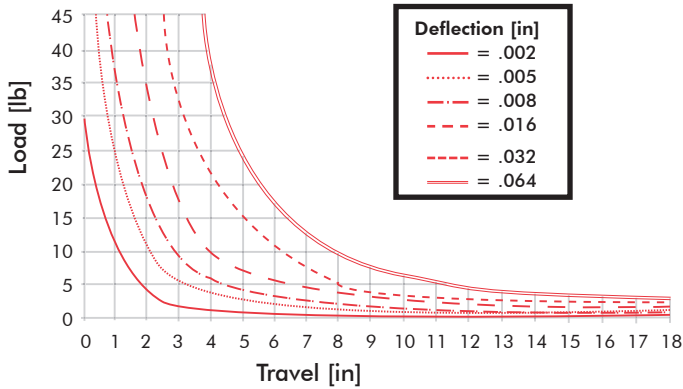

CEC23 with 1/2" Shafts and Composite Bushings

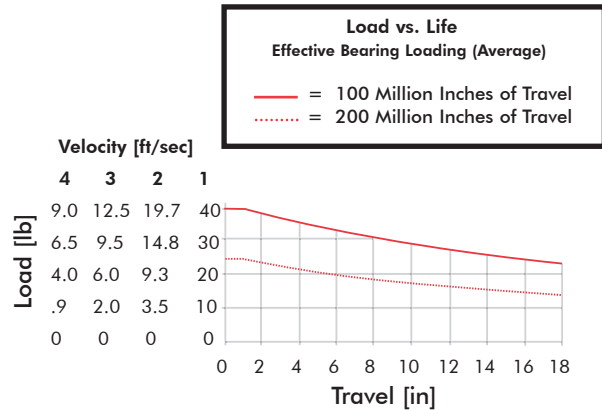
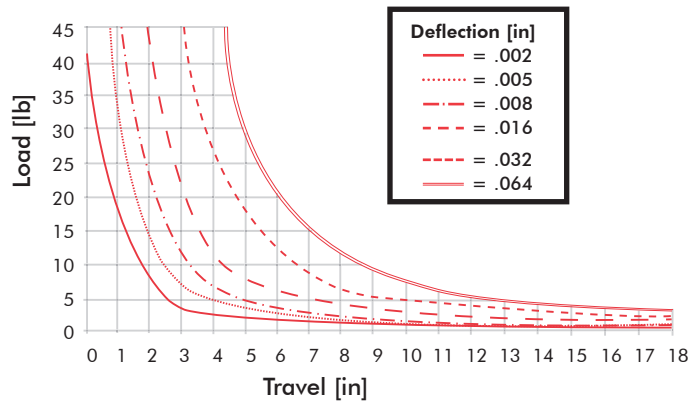

CED23 with 5/8" Shafts and Composite Bushings

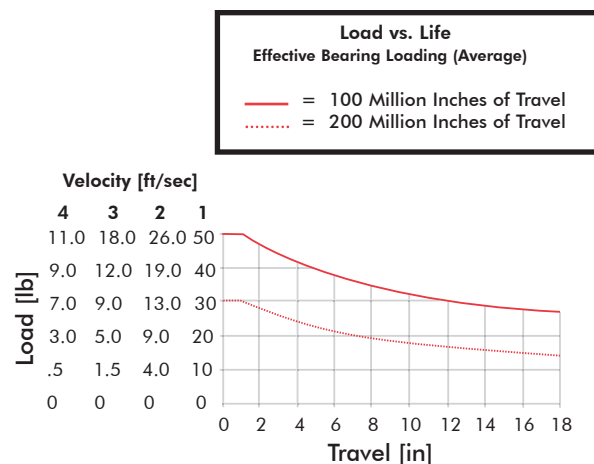
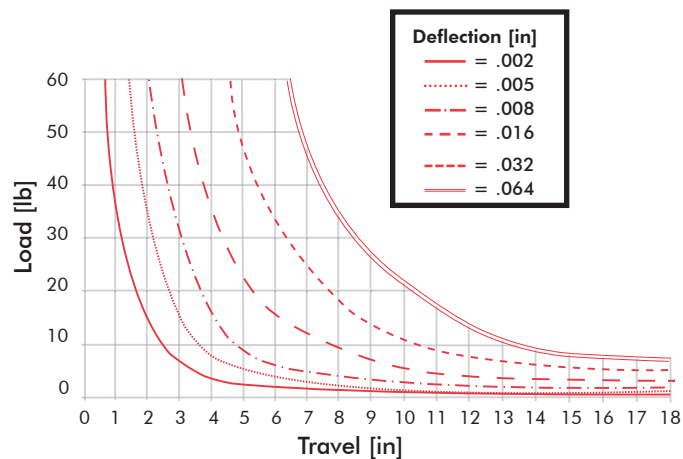

Engineering Data— CD & CE Series

Maximum Rolling Load & Deflection Graphs

CDB24 with 5/8" Shafts and Linear Ball Bushings

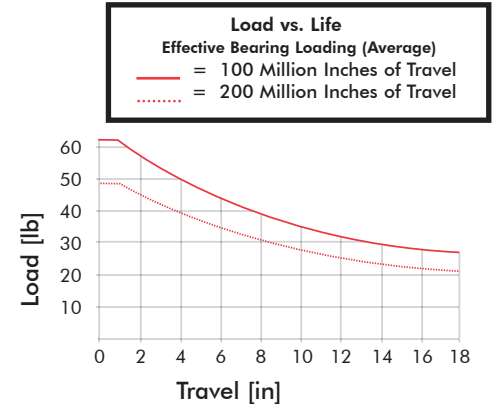
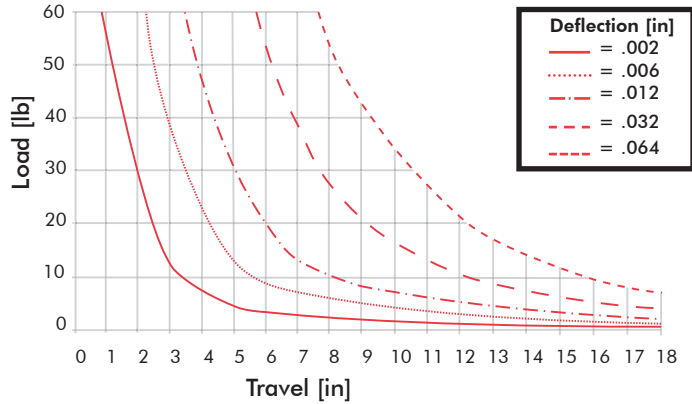

CDC24 with 5/8" Shafts and Composite Bushings

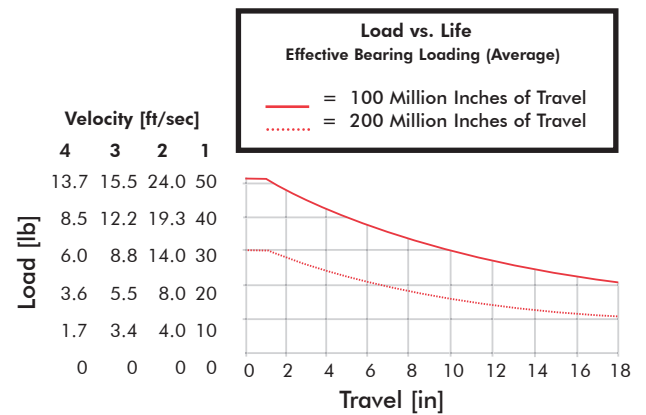
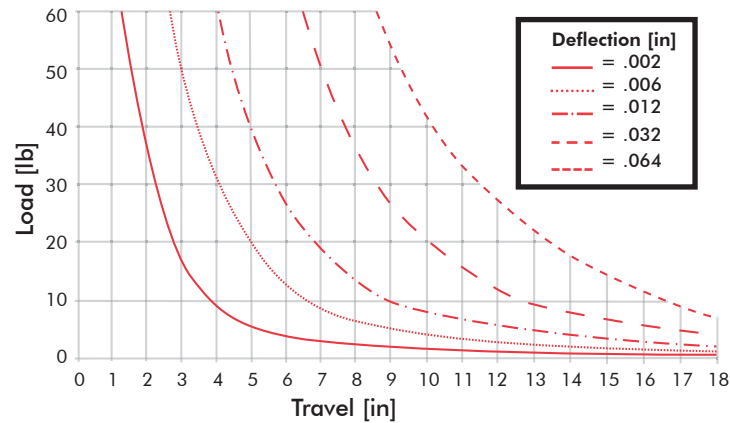

CDD24 with 3/4" Shafts and Composite Bushings

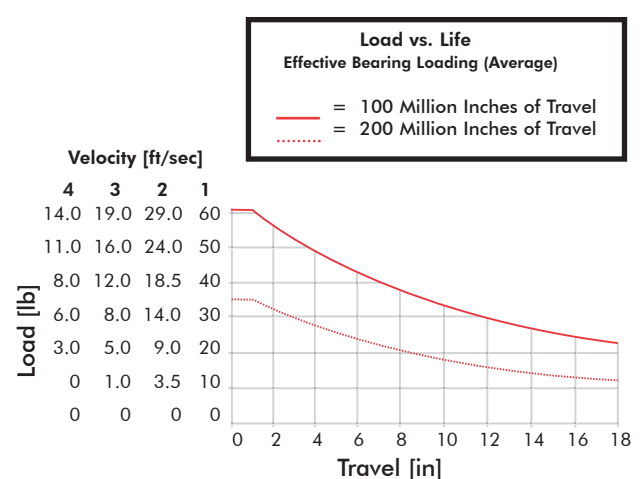
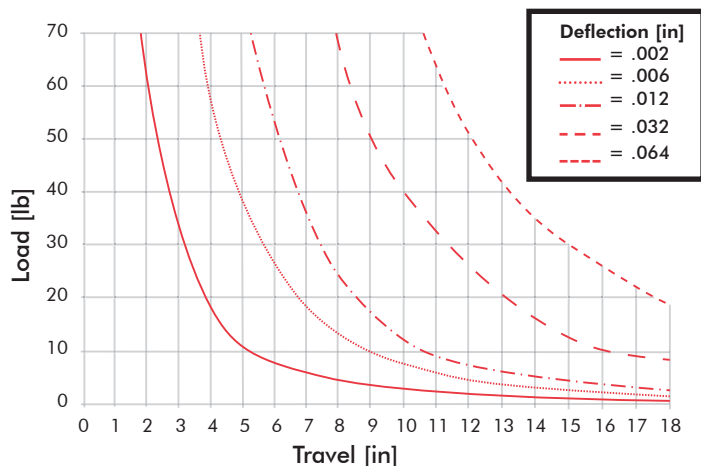

Engineering Data— CD & CE Series

Maximum Rolling Load & Deflection Graphs

CEB24 with 5/8" Shafts and Linear Ball Bushings

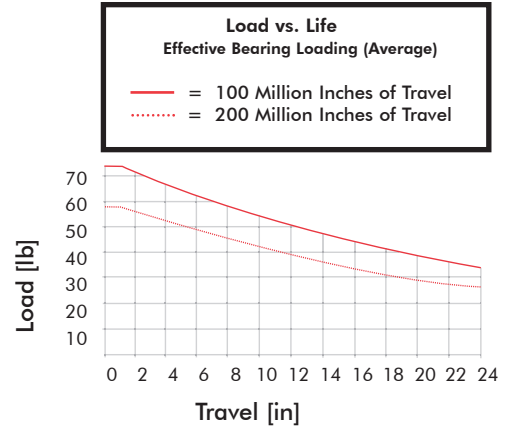
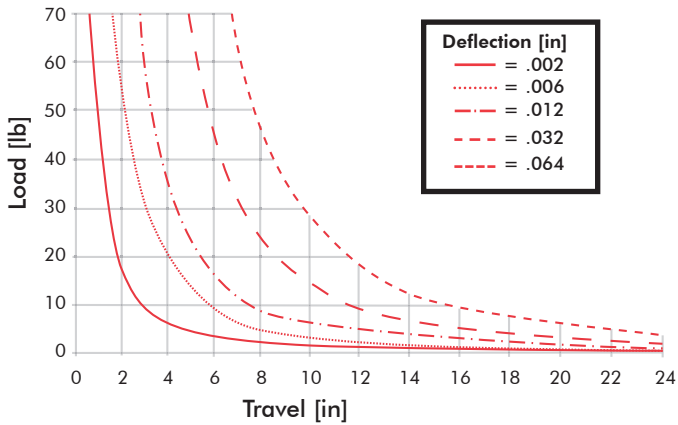

CEC24 with 5/8" Shafts and Composite Bushings

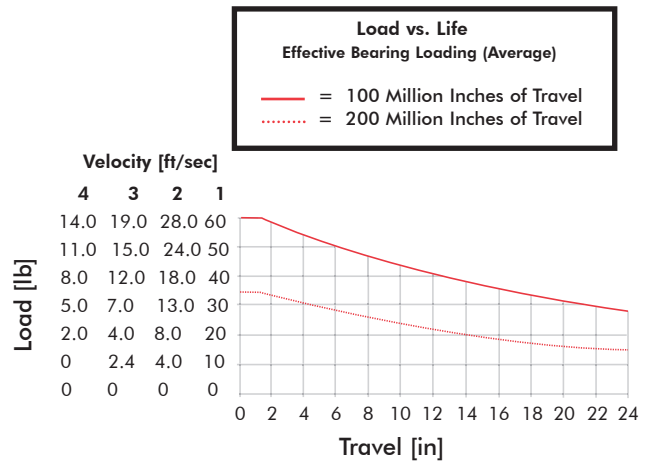
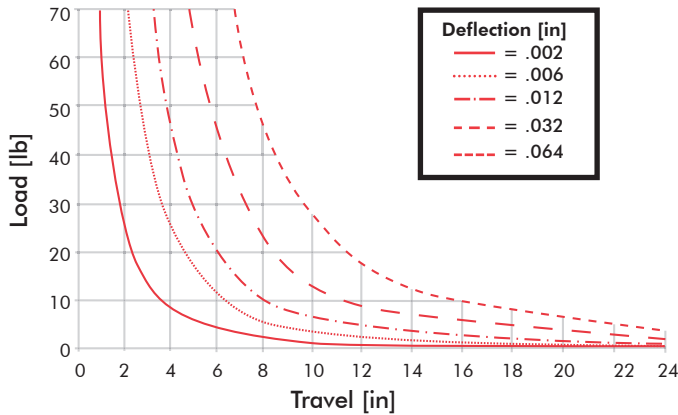

CED24 with 3/4" Shafts and Composite Bushings

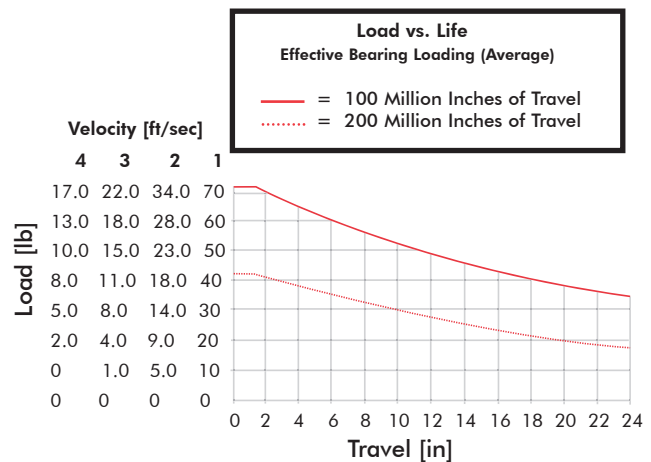
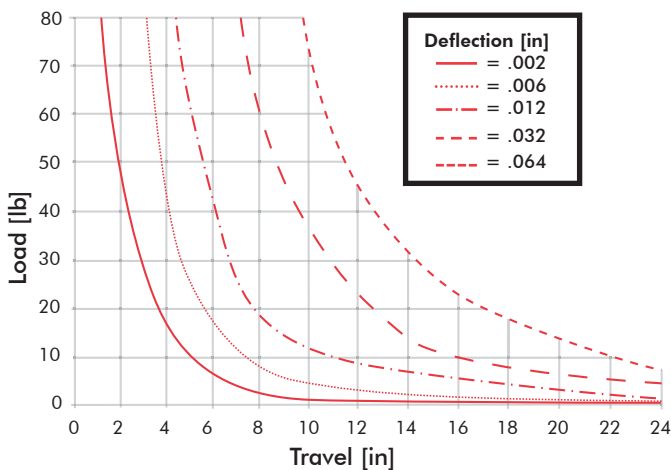

Engineering Data— CD & CE Series

Maximum Rolling Load & Deflection Graphs

CDB25 with 3/4" Shafts and Linear Ball Bushings

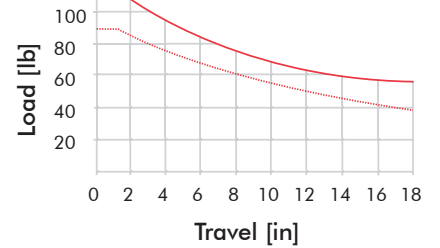
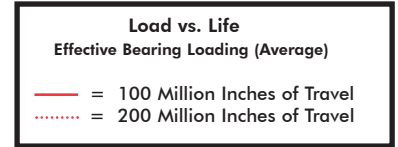
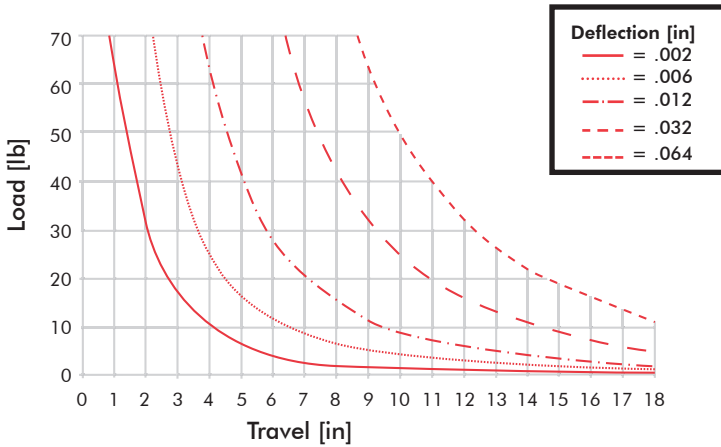

CDC25 with 3/4" Shafts and Composite Bushings

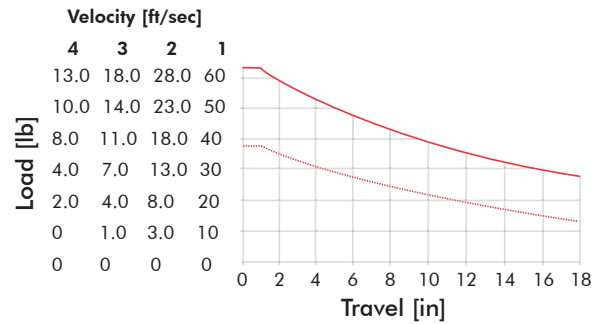
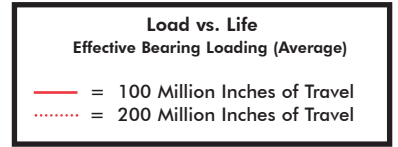
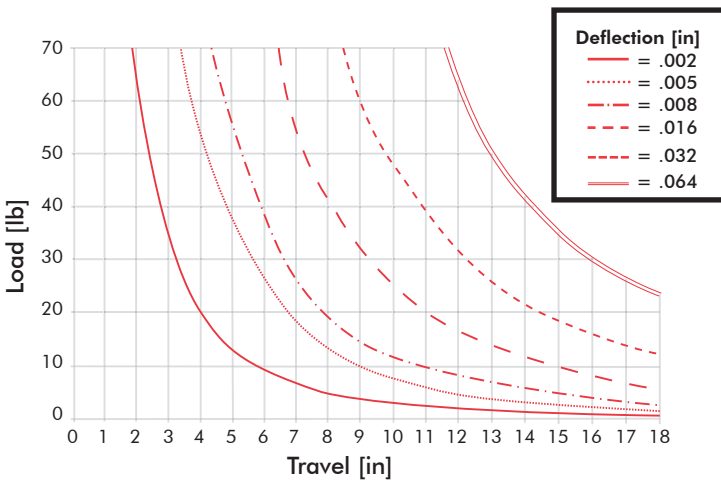

CDD25 with 1" Shafts and Composite Bushings

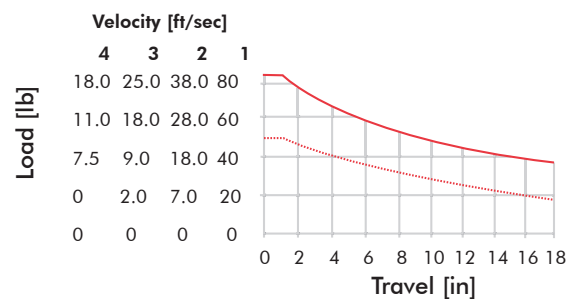
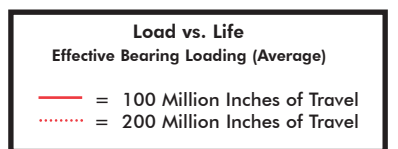
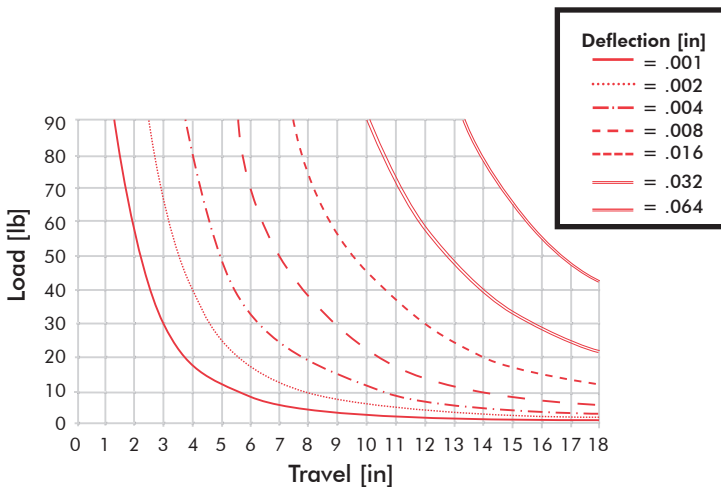

Engineering Data— CD & CE Series

Maximum Rolling Load & Deflection Graphs

CEB25 with 3/4" Shafts and Linear Ball Bushings

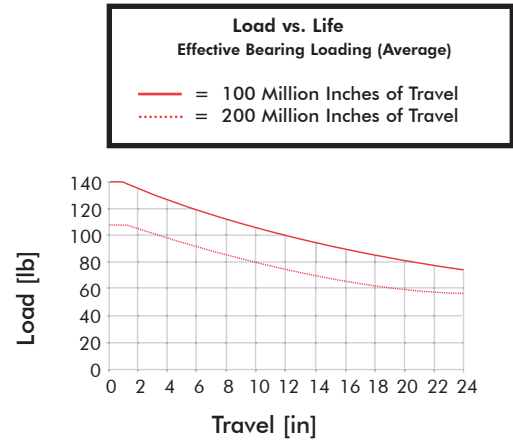
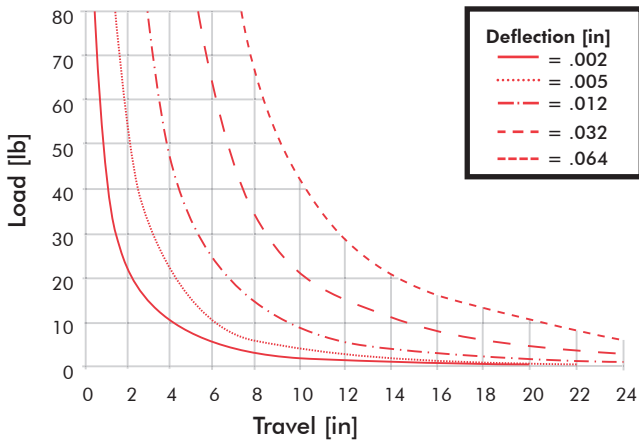

CEC25 with 3/4" Shafts and Composite Bushings

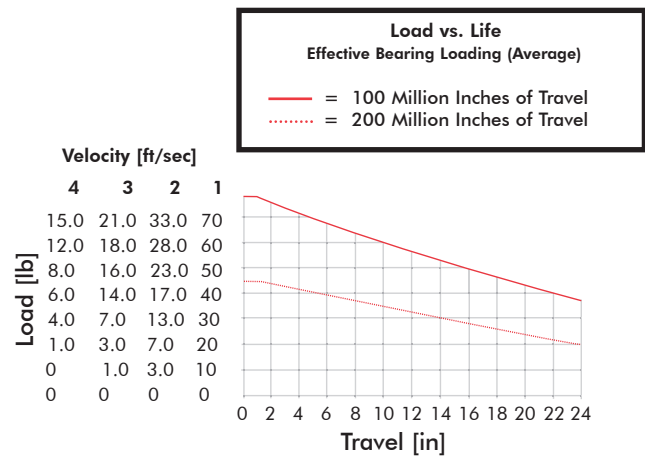
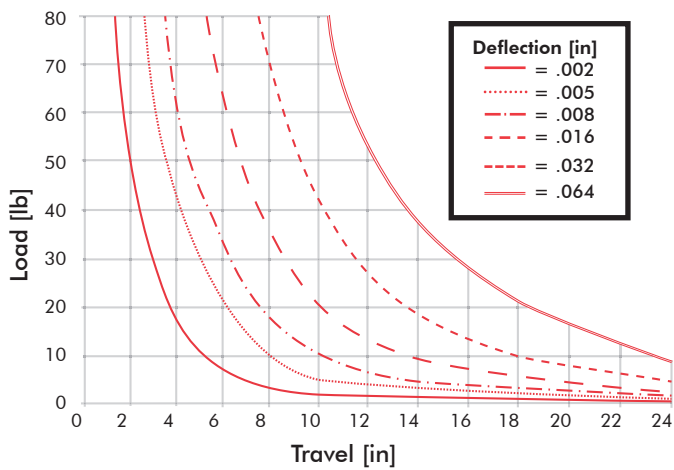

CED25 with 1" Shafts and Composite Bushings

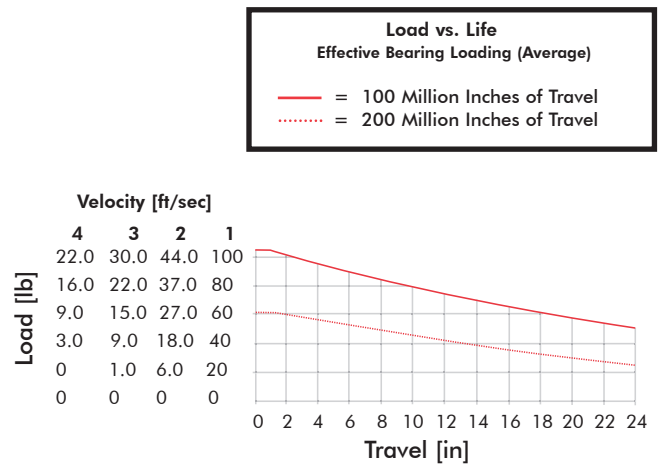
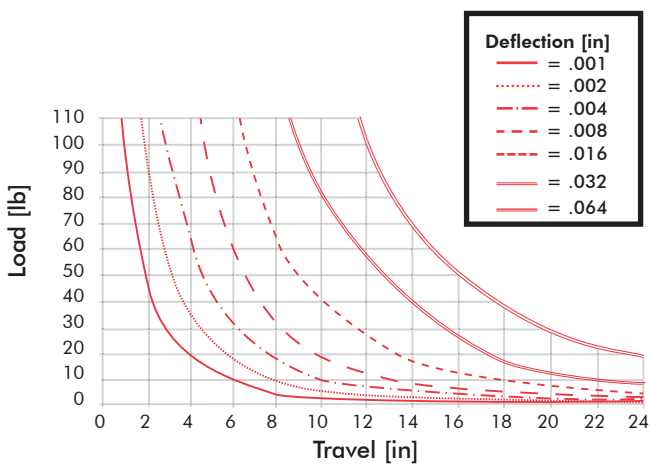

Engineering Data— CD & CE Series

Maximum Rolling Load & Deflection Graphs

CDB26 with 1" Shafts and Linear Ball Bushings

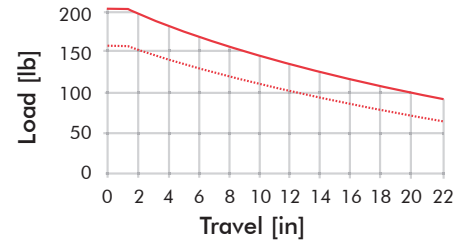
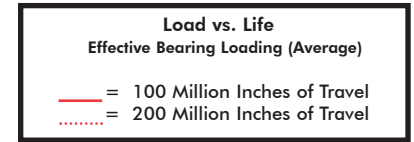
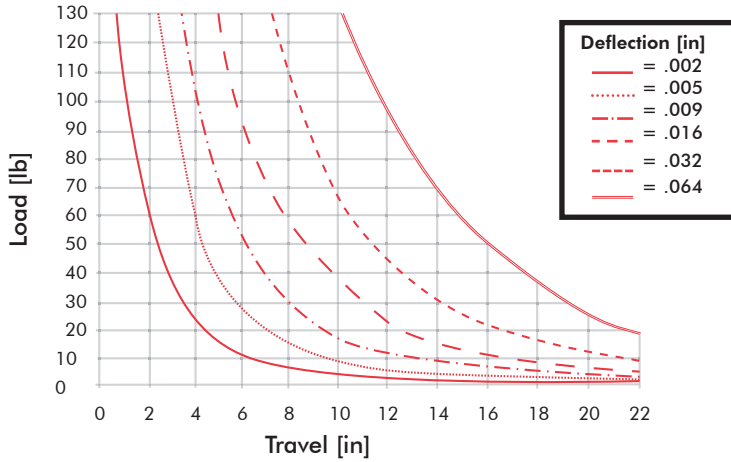

CDC26 with 1" Shafts and Composite Bushings

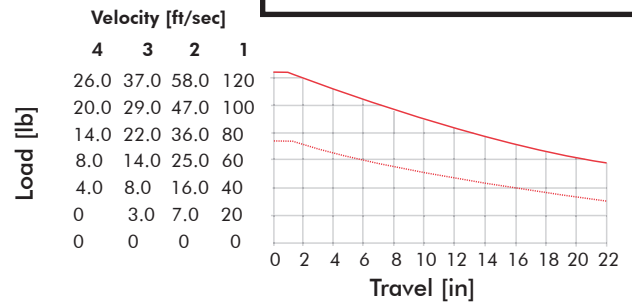
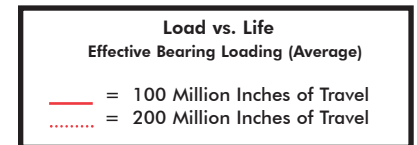
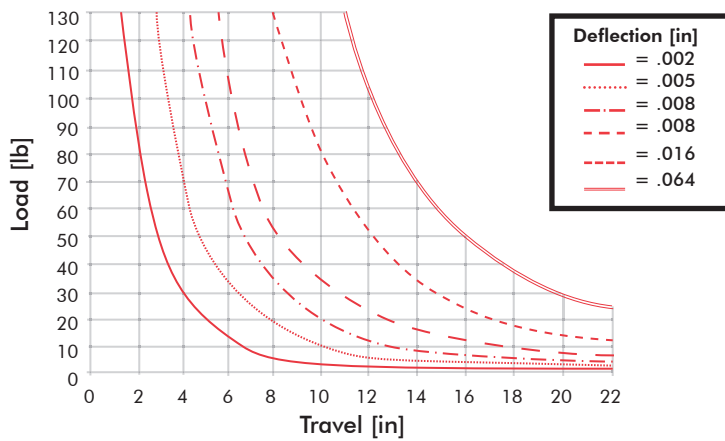

CDD26 with 1 3/8" Shafts and Composite Bushings

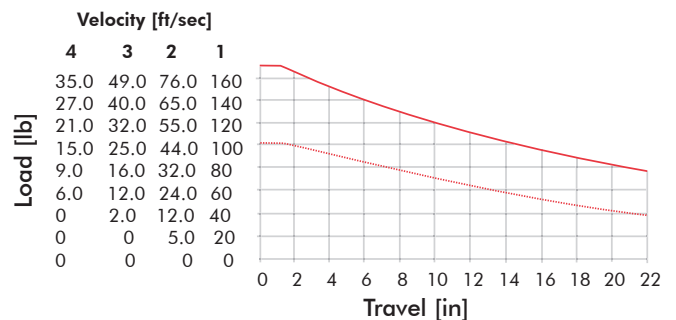
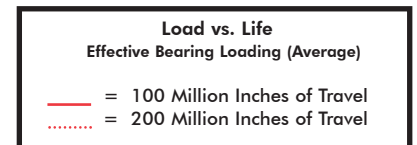
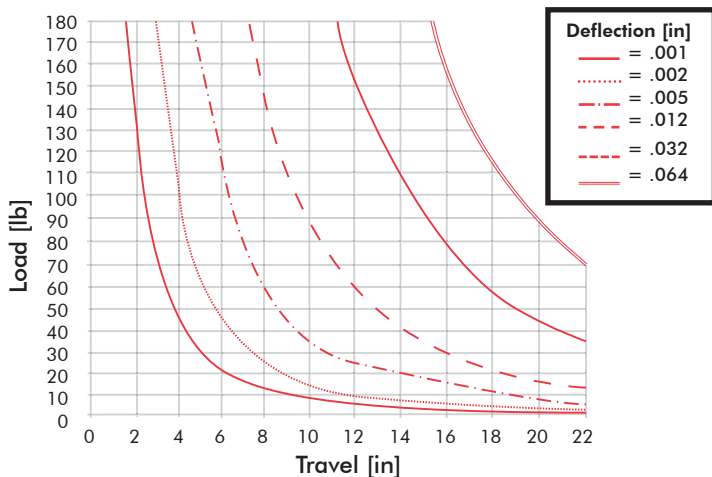

Engineering Data— CD & CE Series

Maximum Rolling Load & Deflection Graphs

CEB26 with 1" Shafts and Linear Ball Bushings

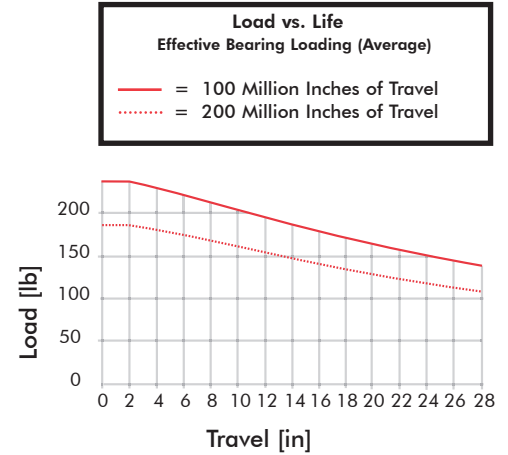
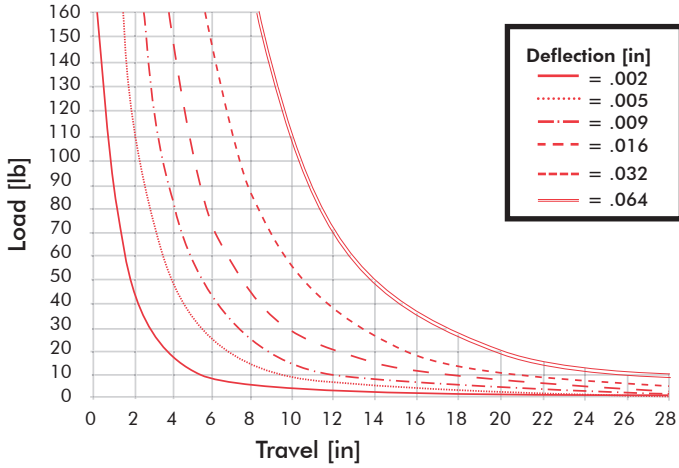

CEC26 with 1" Shafts and Composite Bushings

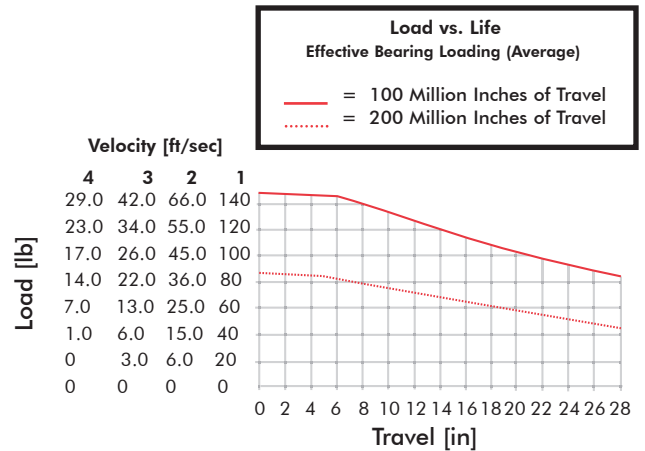
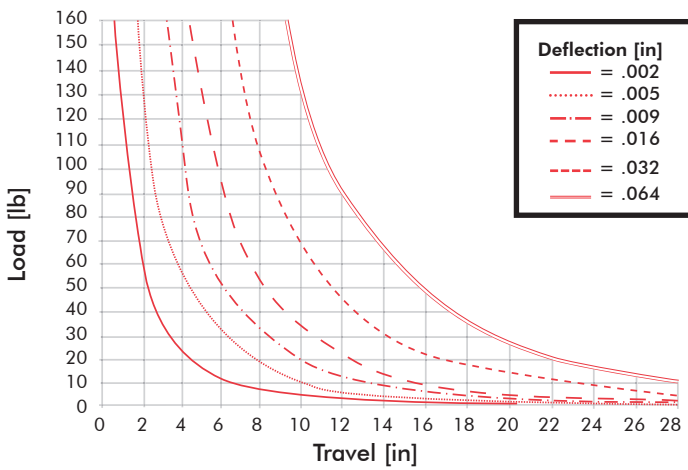

CED26 with 1" Shafts and Composite Bushings

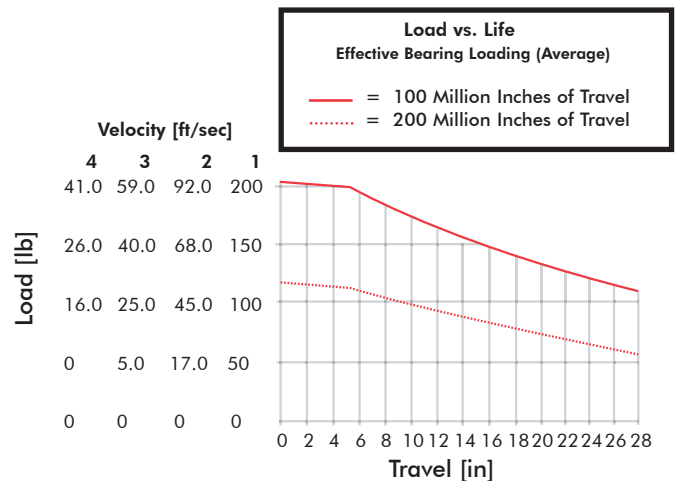
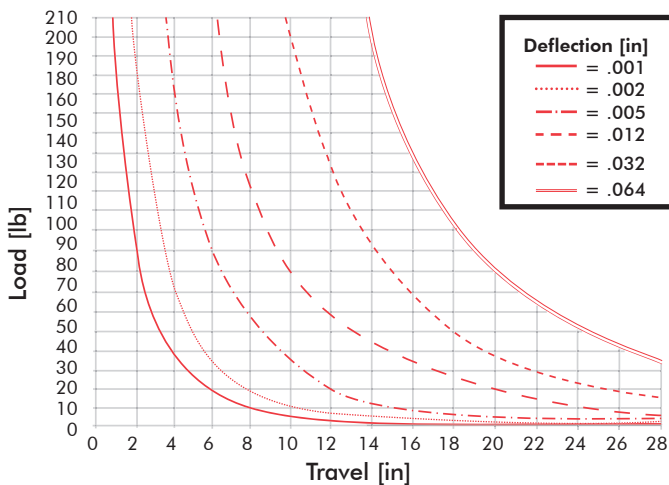

Special Conditions and Limited Warranty

Determination of the suitability of any information or product for the application contemplated by any user or the manner of that use is the sole responsibility of the user.

Turn-Act reserves the right to improve or change designs without notice.

All orders are subject to acceptance by the factory sales department.

Turn-Act agrees to repair or replace to the original purchaser any standard parts or products for a period of 12 months from date of shipment which Turn-Act determines upon inspection to be defective in workmanship or material. Wear components including but not limited to seals and bearings are excluded from this warranty.

Under no circumstance may merchandise be returned without written authorization from the factory.

This warranty is void in the event the product has been tampered with, altered, or serviced by unauthorized personnel.

Turn-Act's total responsibility for any claims, damages, losses or liabilities related to the product covered thereunder shall not exceed the purchase price of such product. In no event shall Turn-Act be liable for any special, indirect, incidental or consequential damages of any character, including but not limited to loss of use of productive facilities or equipment, lost profit, property damage, transportation, installation or removal or lost production whether suffered by purchaser or third party. Turn-Act disclaims all liability for any and all cost, claims demands, charges, expenses, and other damages, either direct or indirect, incident to all property damage arising out of any cause of action based on strict liability. This warranty gives you specific legal rights and you may have other rights, which vary from state to state.

Compact Automation Products, LLC

105 Commerce Way
Westminster, SC 29693

Tel: 864.647.9521

Fax: 864.647.9574

www.compactautomation.com